

Building Design Using Cold Formed Steel Section

Mr. Roshan S Satpute, Dr. Valsson Varghese

M.Tech (Structural Engineering) Karmaveer Dadasaheb Kannamwar College of Engineering,
Professor, Civil Engineering, Karmaveer Dadasaheb Kannamwar College of Engineering,

ABSTARCT: Cold formed steel section are extensively used in industrial and many other non-Industrial constructions worldwide, it is relatively a new concept in India. These concepts were introduced to the Indian market lately in the 1990's with the opening up of the Indian economy and a number of multi-nationals setting up their green-field projects. Global Cold formed steel have established their presence in India by local marketing agents and certified builders. As the complete building package is supplied by a single vendor, compatibility of all the building components and accessories is assured. This is one of the major benefits of the Cold formed building system. When a building is no longer needed it can be disassembled, stored or moved to another location and re-erected because only bolted connections are used. There is no field riveting or welding & the rigid frame is strong. By using Cold formed system economy is achieved with completion of project in minimized time. In this project the detailed analysis of Industrial building with Cold formed concept is carried out. The Work is also extended by taking the parametric studies too. A comparative study has also been carried out between Hot Roll steel Industrial building and Cold formed Industrial building and a conclusion has been drawn.

Keywords: Stad Pro 2008, IS Code,

I. INTRODUCTION

1.1 GENERAL

The design of industrial building is governed mainly by functional requirements and the need for economy of construction. In cross-sections these buildings will range from single or multibay structures of larger span when intended for use as warehouses or aircraft hangers to smaller span buildings as required for factories, assembly plants, maintenance facilities, packing plants etc. The main dimensions will nearly always be dictated by the particular operational activities involved, but the structural designer's input on optimum spans and the selection of suitable cross-sections profile can have an important bearing on achieving overall economy. An aspect where the structural designer can make a more direct contribution is in lengthwise dimensions i.e. the bay lengths of the building. Here a balance must be struck between larger bays involving fewer, heavier main components such as columns, trusses, purlins, crane beams, etc. and smaller bays with a large number of these items at lower unit mass. An important consideration in this regard is the cost of foundations, since a reduction in number of columns will always result in lower foundation costs.

1.2 CLASSIFICATION

- I. Hot-Rolled Steel Industrial building.
- II. Cold-Form Steel Industrial building.

1.3 HOT-ROLLED STEEL INDUSTRIAL BUILDING

The choice of cross-sections for a single storied Hot-Rolled Steel industrial building is very wide, but experience has shown that a limited number of shapes are the most practical and economical. Some of these cross-sections are shown in fig. The cross-sections used in Hot-Rolled Steel Industrial building have yield strength of 250Mpa. The following figure shows the cross section of Hot Rolled Steel Industrial Building.

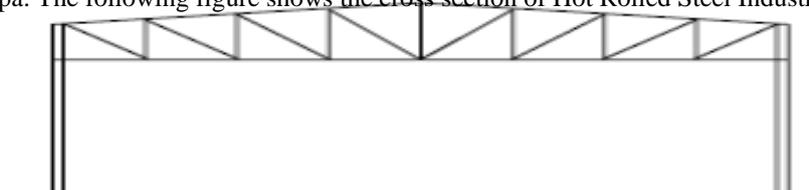

Figure 1.1: Cross-sections used in Hot-Rolled Steel Industrial building

1.4 ORIGIN OF COLD-FORM STEEL CONCEPT

Cold-Form Steel buildings are a predetermined assembly of structural members that has proven over time to meet a wide range of structural and aesthetic requirements. Cold-Form Steel building concept originated during World War II in 1960's in the United States and made available in India in late 90's.

During World War II, best known Pre-fabricated building i.e. Which became a household word was mass produced by hundreds of thousands to meet a need for inexpensive and standardized shelter. Requiring no special skills, these structures are assembled with only hand tools and with no greater effort could be readily dismantled and moved and re-erected somewhere else. The scientific term Cold-Form Steel buildings came into being in the 1960's. The buildings were "Cold- Form Steel" because like their ancestors, they relief upon standard engineering designs for a limited number of off the shelf configurations. As long as the purchaser standard designs the buildings could be properly called Cold-Form Steel.

1.5 COMPONENTS OF COLD-FORM STEEL BUILDING

- Main frame
- Secondary framing
- Wind bracing
- Exterior Cladding

Trapezoidal sheeting is used as exterior cladding. Cold formed Z or C Sections are used as Secondary framing. Main framing consists of built up I-Sections. Wind bracing consists of rods which are circular in cross section.

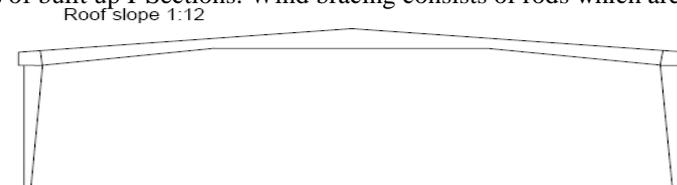

Figure 1.2 (a): Standard Cold-Form Steel portal frames

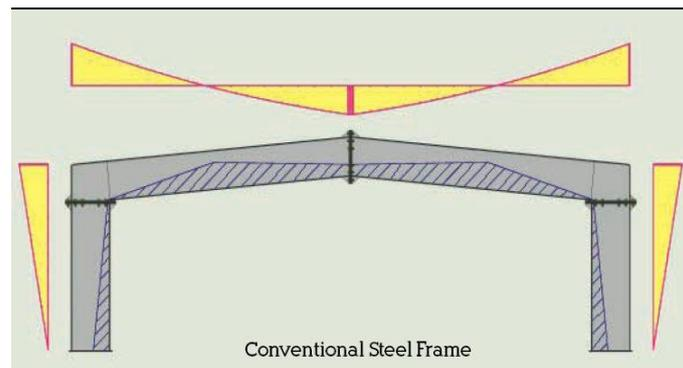

Figure 1.2(b): Conventional frame

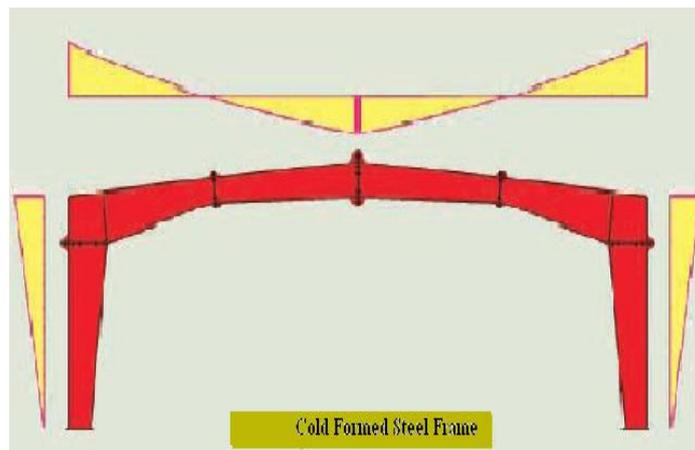

Figure 1.2(c): Cold form steel frame

A typical single-span frame of this design is shown in figure. It will be seen that the columns and rafters are tapered to match the general shape of the gravity bending moment diagram and the high moments at the column-rafter junction and at the apex can thus be accommodated by the deeper section. Uniform flange and web thicknesses can be used, resulting in a frame width. The higher fabrication cost of the tapered, welded construction is more than offset by the much reduced material content. The mass can be as little as 75 percent of a Hot-Rolled Steel rolled-steel portal frame of similar size. Web thicknesses are as small as 5mm and flange thicknesses 8mm.

Such thin-webbed sections require Non-Hot-Rolled Steel design fabrication procedures and the specialist fabricators use computer aided design and detailing routines and automated shop assembly methods.

1.6 MAJOR COMPONENTS OF COLD-FORM STEEL INDUSTRIAL BUILDING

Cold-Form Steel building uses three distinct product categories:

- a) Built-up "I" section as primary structural framing members consisting of columns and rafters made up of hot rolled sections having yield strength of 345Mpa.
- b) Cold formed "C" and "Z" shaped secondary members such as purlins, eave struts and side girts having yield strength of 345Mpa.
- c) Profiled sheets for roof and wall cladding having yield strength of 345Mpa.

1.7 ADVANTAGES OF COLD FORMED SECTIONS OVER HOT ROLLED STEEL SECTIONS

- No insect and fungal infection: The problems such as rotten and discomposed due to insect and fungal infection are eliminated.
- Consistency and accuracy of profile: The nature and manufacturing of process Cold-rolling enables the desired profile maintained and repeated for as long as it is required, in a much closed tolerance. Moreover, the very little tool wears and the cold rolling process is ideally suited to computerized operation which assists to the maintenance of accuracy.
- Versatility of profile shape: Almost any desired cross-sectional shape can be produced by cold-rolling, such as Z-section with lips and C-section with lips.
- It could be pre-galvanized or pre-coated: The steel material may be galvanized or coated by plastic materials either to enhance its resistance to corrosion or as an attractive finish.
- Best suited for site erection: The cold formed steel may be more advantageous than hot rolled steel since it can be cut and erected with very light machine and even only manpower.
- Increase in yield strength due to cold-forming: The cold-forming process introduces local work hardening in the strip being formed in the vicinity of formed corners. This local work hardening may results an increment of ultimate yield strength about 25% from its virgin strength.
- Minimization of material: Since the material used can be very thin in comparison to lower thickness limits of hot rolled sections, it allows the material usage for a given strength or stiffness requirements to be much less than that of the smallest hot rolled sections. The material thickness or even the cross-sectional geometry could be controlled to achieve the structural features with minimum material weight.

II. PLANNING OF COLD-FORM STEEL BUILDING FOR INDUSTRIAL PURPOSES

2.1 GENERAL

The planning of an Industrial building is based on functional requirements i.e. on the operations to be performed inside the building. In the planning of an Industrial building, due consideration should be given to factors such as wide area of primary frames, large height, large doors and openings, large span of primary frames, consistent to give minimum weight of primary frames, purlins, girts, eave struts etc. and lighting and sanitary arrangement. The site for a proposed plant is in general, pre-selected before it comes for design. But it is better to discuss with the designer the preliminary plans in advance. This gives the designer an opportunity to choose a suitable site giving due consideration to future developments. Some of the factors governing the site selection are as listed below:

- The site should be located on an arterial road.
- Facilities like water, electricity, telephone, etc.
- Topography and water drainage.
- Soil condition with reference to foundation design.
- Sufficient space should be available for storage of raw materials and finished products.

- Sufficient space should be available for transportation facilities to deliver raw materials and collect the finished products.
- Water disposal facilities.

2.2 PRIMARY COLD-FROM STEEL FRAME

Assuming that a Cold-From Steel building system is selected for the project at hand, the next milestone is choosing among the available types of Cold-From Steel primary frame. Proper selection of the primary framing, the backbone of Cold-from Steel buildings, goes a long way toward a successful implementation of the design steps to follow. Some of the factors that influence the choice of main framing include:

- Dimensions of the building: width, length, and height.
 - Roof slope.
 - Required column-free clear spans.
 - Occupancy of the building and acceptability of exposed steel columns.
 - Proposed roof and wall materials.
- At present five basic types of Cold-From Steel frame are currently in the market:
- Tapered beam.
 - Single-span rigid frame.
 - Multi-span rigid frame.
 - Lean-to frame.
 - Single span and continuous trusses.

“Frame width” is measured between the outside surfaces of girts and eave struts. “Clear span” is the distance between the inside faces of the columns. “Eave height” is measured between the bottom of the column base plate and eave strut. “Clear height” is the distance between the floor and the lowest point of the structure.

2.3 SECONDARY FRAMING

Secondary structural members span the distance between the primary building frames of the Cold-From Steel building systems. They play a complex role that extends beyond supporting roof and wall covering and carrying exterior loads to the main frame. Secondary structural, as these members are sometimes called, may serve as flange bracing for primary framing and may function as a part of the building’s lateral load- resisting system. Roof secondary members, known as purlins, often form an essential part of horizontal roof diaphragms; wall secondary members, known as girts are frequently found in wall bracing assemblies. A third type of secondary framing, known by the names of eave strut, eave purlin, or eave girt, acts as part purlin and part girt its top flange supports roof panels, its web, wall siding. Girts, purlins and eave struts exhibit similar structural behaviour.

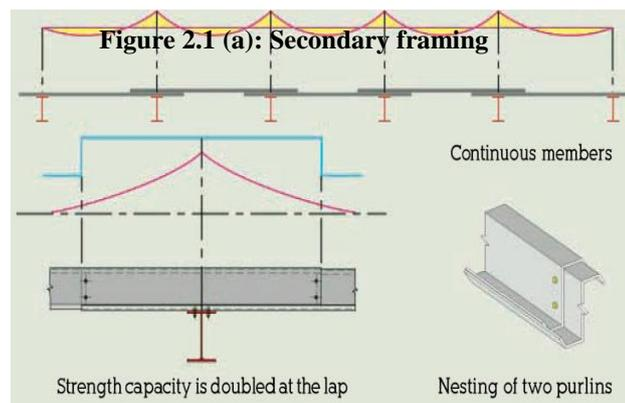
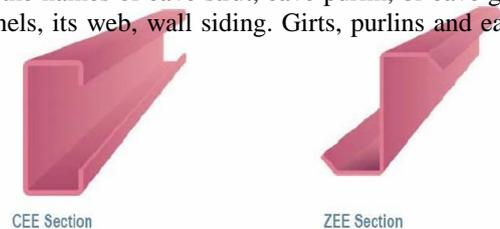

Figure 2.1 (b): Overlapping of secondary members
III. CASE STUDY

3.1 COLD FORMED STEEL CONCEPT FOR INDUSTRIAL BUILDING

3.1.1 INTRODUCTION

In Cold-form steel Industrial building span range is kept between 10m-18m. The available profiles of slopes for Industrial building are 1:10, 1:12 & 1:20

3.1.2 PARAMETERS OF COLD-FORM STEEL INDUSTRIAL BUILDING

Location:	Nagpur
Utility:	Cement Godown
Building width;	15m
Building Length:	50m
Eave height:	5m
c/c of main frames :	6.25 m
Maximum spacing of purlin:	1.5m
Slope of Roof:	1:12
Aria Covered:	15 m × 50 m

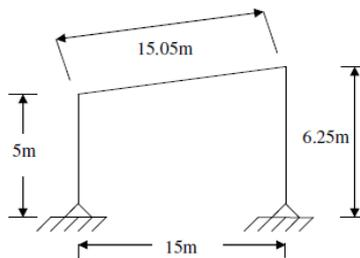

Figure 3.1.1: Plan of CFS

$$\tan \theta = \frac{1}{12}$$

$$\theta = \tan^{-1}\left(\frac{1}{12}\right)$$

$$= 4.76$$

$$\cong 5^\circ$$

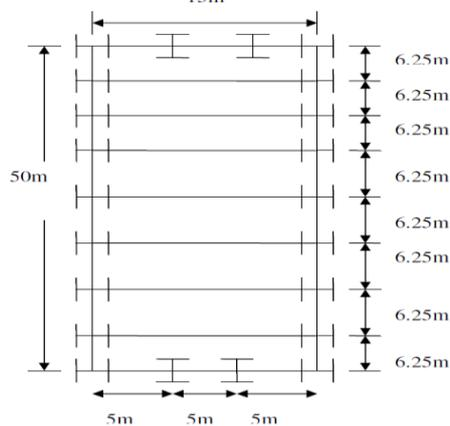

Figure 3.1.2: Elevation of CFS

3.1.3 LOADING

A) IMPOSED LOAD

As per Table 2 of IS: 875(Part2)

UDL on roof measured on plan area for slope less than $10^\circ = 75 \text{ kg/m}^2$

B) WIND LOAD

According to value 5.3 of IS 875 (part3)

$$v_2 = v_b k_1 k_2 k_3$$

Location assumed $v_b =$ Nagpur

Basic wind speed (v_b) = 44 m/s

$k_1 = 1$ coefficient from table 1 of IS 875 (part3)

$k_2 = 0.88$ from table 2 of IS 875 (part3)

$k_3 = 1$ topography factor

Design wind speed $v_2 = 44 \times 1 \times 0.88 \times 1$

$$= 38.72 \text{ m/s}$$

Design wind pressure $p_z = 0.6 v_2^2$

$$= 0.6 \times 38.72^2$$

$$= 900 \text{ m/s}$$

3.1.4 Calculation Of External Pressure Coefficient “ Cpe ”

Roof

Referring to Table 6 of IS: 875(Part3)

Here $h = 5\text{m}$; $w=15\text{m}$

Roof Angle = 5°

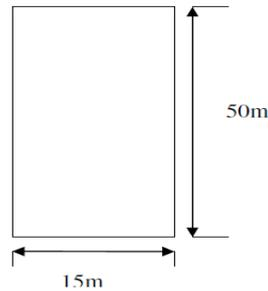

Figure 3.1.3: Building Plan

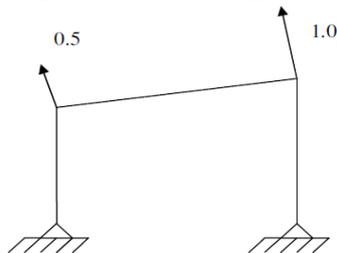

Figure 3.1.4: Wind Across Length Of Building (Roof)

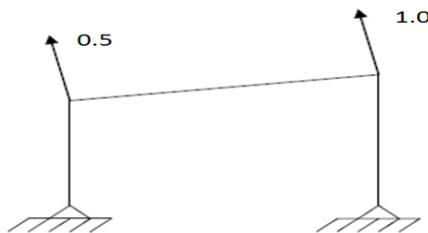

Figure 3.1.5: Wind Along Length Of Building (roof)Wall

Referring to Table 4 of IS: 875(Part3)

$$h/w = 5/15 = 1/3 < 1/2$$

$$l/w = 50/15 = 3.33 < 4$$

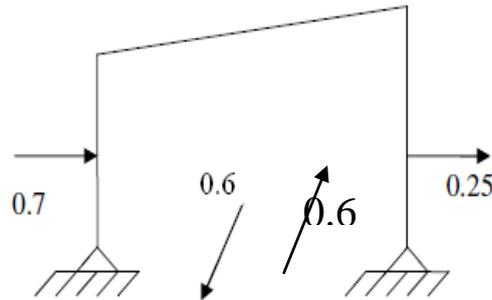

Figure 3.1.6: Wind across Length Of Building (Wall)

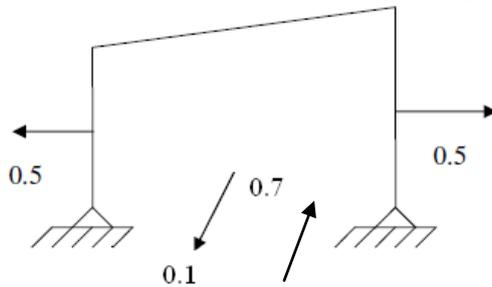

Figure 3.1.7: Wind Along Length Of Building (Wall)

Considering openings to be < 5 % of Total Area
 Internal pressure coefficient = ± 0.2

3.1.5 PURLIN DESIGN

a) Dead Load:

$$\begin{aligned} \text{Unit wt. /m of sheeting @ } 0.06 \text{ kn/m}^2 \\ &= 0.06 \times 1.5 \\ &= 0.09 \text{ kn/m} \end{aligned}$$

$$\text{Unit wt./m or Self wt. of Purlin} = 0.07 \text{ KN/m}$$

$$\text{Total Dead Load per metre on each Purlin} = 0.16 \text{ KN/m}$$

b) Imposed Load

$$\text{Imposed Load intensity on Purlin} = 0.75 \text{ KN/m}^2$$

$$\text{Total Imposed Load per metre on each Purlin} = 0.75 \times 1.5 = 1.125 \text{ KN/m}$$

c) Wind Load

$$\begin{aligned} \text{Maximum Wind Load per metre on each Purlin} &= (1 + 0.2) \times 1.161 \times 1.5 \\ &= 1.62 \text{ kn/m} \end{aligned}$$

Load Combination1- Dead Load + Imposed Load

$$= 0.16 + 1.125 = 1.285 \text{ KN/m}$$

Load Combination2- Dead Load + Wind Load

$$= 0.16 - 1.62 = 1.46 \text{ KN/m}$$

Choose z section

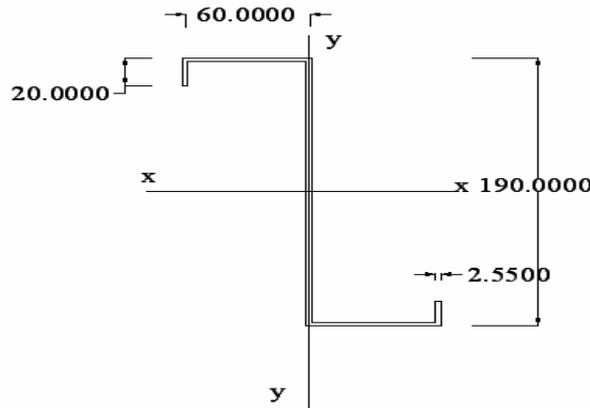

Figure 3.1.8: Z section

Table 3.1.1: Property of the Z-section selected is as shown below

Area	Thickness	Wt/m	I _{xx}	I _{yy}	Z _{xx}	Z _{yy}
8.37 _{sq.m}	2.55 _{mm}	6.57 _{kg/m}	439 _{cm⁴}	58.4 _{cm⁴}	46.21	10.01

Checking the above section based on Section 9 of BS: 5950 Part5-1998

1. Overall Depth < 100 t
 190mm < 100×2.55
 190 < 255 (Ok)
2. Overall Width of Compression Flange/ Thickness i.e. B/t < 35
 60/2.55 = 23.52mm < 35mm (O.K.)
3. Width of Lip > B/5
 20mm > 60/5
 20mm > 12mm

Checking the above section based on IS: 801-1975

$$W/t = (60 - 2 \times 5.55)/2.55 = 21.52$$

5 Minimum Overall depth required as per clause no.5.2.2.1 of IS: 801-1975

$$= 2.8 t^6 \sqrt{(w/t)^2 - \frac{281200}{fy}}$$

$$fy = 3450 \text{ kg/cm}^2$$

$$= 2.8 t^6 \sqrt{(21.52)^2 - \frac{281200}{3450}}$$

$$= 15\text{mm} < 20\text{mm}$$

$$4.8t = 4.8 \times 2.55 = 12.24 < 15\text{mm (OK)}$$

6 Calculation for laterally unbraced beams

Calculation of effective design width of compressive element as per clause no.5.2.2.1 of IS: 801-1975

$$\left(\frac{w}{t}\right)_{lim} = \frac{1435}{\sqrt{f}}$$

$$\text{Where } f = 0.75 \times 1600 \text{ kg/cm}^2$$

$$= \left(\frac{w}{t}\right)_{lim} = \frac{1435}{\sqrt{f}}$$

$$W = 41.4 \times 2.55 = (60 - 2 \times 2.55)$$

$$105.57 > 54.9 \text{ (OK)}$$

Hence full flange is effective in compression referring to clause no.6.3 (b) of IS: 801-1975

$$\frac{L^2_{sxc}}{d_{lyc}} \text{ Where,}$$

L = Unbraced Length of the member = 2.08m (considering sag rods at spacing 2.08m)

I_{yc} = Moment of inertia of the compression portion of a section about the gravity axis of the entire section parallel to the web = I_y/2 = 58.8/2 = 29.4

$$S_{xc} = Z_{xx} = 46.21 \text{ cm}^3$$

$$\begin{aligned}
 E &= 2 \times 10^6 \\
 f_y &= 3450 \\
 D &= \text{Depth of the section} = 190\text{mm} \\
 \frac{L^2 s_{xc}}{d i_{yc}} &= \frac{208^2 \times 46.21}{19 \times 29.4} \\
 &= 3579 \longrightarrow (1) \\
 \frac{0.18\pi^2 Ecb}{f_y} &= \frac{0.18 \times \pi^2 \times 2 \times 10^6 \times 1}{f_y} \\
 &= 1030 \longrightarrow (2) \\
 \frac{0.9\pi^2 Ecb}{f_y} &= \frac{0.9 \times \pi^2 \times 2 \times 10^6 \times 1}{f_y} \\
 &= 5150 \longrightarrow (3) \\
 &(1) > (2) \\
 &(1) < (3)
 \end{aligned}$$

$$\begin{aligned}
 \text{Hence } F_b &= \frac{2}{3} f_y - \frac{f_y^2}{2.7\pi^2 Ecb} \left(\frac{l^2 \times s_{xc}}{d \times i_{yc}} \right) \\
 F_b &= \frac{2}{3} 3450 - \frac{3450^2}{2.7 \times \pi^2 \times 2 \times 10^6 \times 1} (3579) \\
 &= 1500.7 \text{ kg/cm}^2 \\
 F_b &= 150.7 \text{ N/mm}^2
 \end{aligned}$$

Referring Clause no. 6.1 @ IS 801-1975

$$\begin{aligned}
 F &= \text{Basic design stress} = 0.6 f_y \\
 &= 0.6 \times 3450 = 2070 \text{ kg/cm}^2
 \end{aligned}$$

Hence safe = 207 N/mm²

Hence $F_b = 150.07 \text{ N/mm}^2$

Since here Wind load condition is critical,

$$F_b = 1.33 \times 150.07 = 199.59 \text{ Mpa}$$

$$\begin{aligned}
 F_{b \text{ act}} &= \frac{M}{Z_{xx}} = \frac{5.84 \times 10^6}{46.21 \times 10^3} \\
 &= 126.37 < 199.59 \text{ Mpa}
 \end{aligned}$$

Check for Deflection according to BS 5950

a) Permissible Deflection due to Imposed load on purlin as per BS 5950

$$\begin{aligned}
 \delta_{perm} &= \frac{\text{span}}{240} \\
 &= 6250 / 240 \\
 &= 26.06\text{mm}
 \end{aligned}$$

$$\text{Load due to Imposed load only} = 1.125 \times 6.25 = 7.03 \text{ KN}$$

b) Calculated Deflection due to Imposed load on Purlin

$$\begin{aligned}
 \delta &= \frac{5wl^3}{384EI} \\
 &= \frac{5 \times 7.03 \times 10^3 \times 6250^3}{384 \times 2 \times 10^5 \times 439 \times 10^4}
 \end{aligned}$$

$$= 25.46 \text{ mm} < 26.04 \text{ mm}$$

Hence found safe when checked for deflection

c) Calculation for Shear Stress in web referring to Clause .no. 6.4 of IS: 801-1975

$$h = 190 - (2 \times 2.55) = 178.9\text{mm}$$

$$h/t = 70.15$$

$$4590 = 78.14$$

$$\frac{4590}{\sqrt{f_y}} = 7814 > 70.15$$

Hence Maximum Average Permissible shear stress,

$$f_v = \frac{1275\sqrt{f_y}}{h/t}$$

$$f_v = \frac{1275\sqrt{f_y}}{70.15}$$

$$\text{But } F_y = 0.4f_y \times 3450$$

$$1380 \text{ kg/cm}^2$$

$$f_v = \frac{1275\sqrt{1380}}{70.15}$$

$$= 67.51 \text{ N/mm}^2$$

Actual Shear stress for Dead Load + Wind Load = 1.46 KN/m

$$\text{Actual Shear stress} = \frac{1.46 \times 10^3 \times 625}{178 \times 2.25}$$

$$= 20 \text{ N/mm}^2$$

$$= 20 \text{ Mpa} < 67.51 \text{ N/mm}^2$$

$$= 20 \text{ Mpa} < 67.51 \times 1.33 \text{ N/mm}^2$$

$$= 20 < 89.78 \text{ Mpa}$$

c) Check for combine shear & building in web

Referring to clause no 6.4.2 & 6.4.3 of IS 801- 1975

$$F_{bw} = 36560000 / (h / t)^2$$

$$F_{bw} = 36560000 / (70.15)^2$$

$$F_{bw} = 7429.3 \text{ kg/cm}^2$$

$$F_{bw} = 742.39 \text{ N/mm}^2$$

$$F = 0.6 \times 3450 = 2072 \text{ kg/cm}^2 = 207 \text{ N/mm}^2$$

$$= \sqrt{(f_{bw}/F_{bw})^2 \times (f_v/F_v)^2} \leq 1$$

$$= \sqrt{\left(\frac{126.37}{199.59}\right)^2 + \left(\frac{20}{89.78}\right)^2}$$

$$= 0.67 < 1 \text{ safe}$$

3.1.6 END WALL COLUMN DESIGN

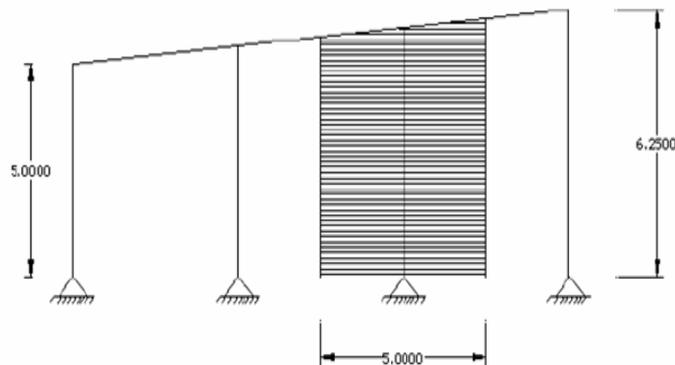

Figure 3.1.9: Column Elevation

Loadings:

Bending Moment on end wall Column due to Wind load from Gable end side Axial

Compressive Load due to Self weight of side sheeting, girt etc. Consider End wall Column spacing 5m

C/C

a) Dead Load

Assume Self weight due to side sheeting and Girt = 0.16 KN/m.

Load at each node (junction with side Girt) on end wall Column $0.16 \times 5 = 0.8 \text{ KN}$ Axial

Compressive Load on end wall column due to Side sheeting & Girt $= 0.8 \times 3 = 2.4 \text{ KN}$.

Where 3 is the number of Girts Assume Self Weight of Column = 1.5KN.

Maximum Length of End wall Column = 5.84m. Total Axial Compressive Load

$$= 1.5 + 2.4 = 3.9 \text{ KN}.$$

b) Wind Load

Wind Load on End wall Column due to Wind influence area

$$= 5 \times 5.84 \times 0.9 \times 0.9 = 23.65 \text{ KN}.$$

Consider End wall Column pinned at both the ends.

$$\text{Max} = \frac{23.65 \times 5.84}{8} = 17.26 \text{ KN.m}$$

Shear Force at ends (supports) due to Wind Load = $23.65 / 2 = 11.83 \text{ KN}$

Choose Cross Section

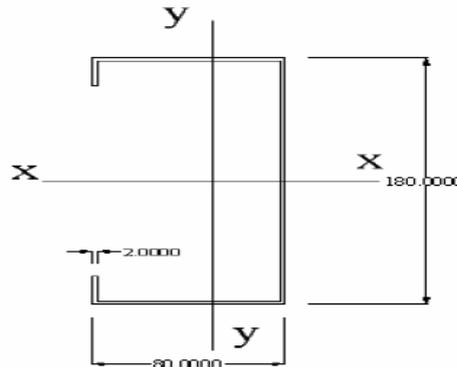

Figure 3.10: C section

3.1.2: properties of C section

Area	Unit/m	Ixx	Iyy	Zxx	Zyy	Rxx	Ryy
28.4Sq M	22.4 kg/m	1408cm ²	432cm ⁴	156.4cm ³	54m3	7.04cm	3.9cm

As per clause no. 6.6.3 of I. S 801 – 1975

$$KL / (Rx) = (l \times 584) / 7.04 = 82.95 < 200$$

$$KL / YX = (L \times 150) / 3.9 = 38.46 < 200$$

Finding out “Fa₁” i.e. Permissible average compressive stress as per Clause no. 6.6.1.1of IS: 801-1975

$$C_c = \sqrt{\frac{2\pi^2 E}{F_y}}$$

$$= \sqrt{\frac{2\pi^2 \times 2 \times 10^6}{3450}}$$

$$= 107$$

Calculating of effective design width of compression element as per clause 5.2.1.1 of IS 801 – 1975

$$(w/t)_{Lim} = 1435 / \sqrt{f} = 1435 / \sqrt{20}$$

$$\text{Cosider shrea in compression } (w/t)_{Lim} = \frac{1435}{\sqrt{20}} = 321$$

OR

$$W = 321 \times 4 = 1284$$

$$Q = 1 \{ Q = \text{Effective Design Area or gross area} \}$$

$$\text{Max } \frac{kl}{r} = 82.95 < C_c = 107$$

As $\frac{kl}{y} < c_c$ Accroding to clause no. 6.6.1.1 (b) IS 801 – 1975

$$\left[\frac{1 - \left(\frac{kl}{r}\right)^2}{2(C_c)^2} \right] f_y$$

$$\frac{5}{3} + \frac{3}{8} \times \left(\frac{kl/r}{C_c} \right) - \left(\frac{(kl/r)^3}{8(C_c)^3} \right)$$

$$\left[\frac{1 - (82.95)^2}{2(107)^2} \right] \times 3450$$

$$\frac{5}{3} + \frac{3}{8} \times \left(\frac{82.95}{107} \right) - \left(\frac{(82.95)^3}{8(107)^3} \right)$$

$$= 1276.39 \text{ kg/cm}^2$$

$$= 127.64 \text{ N/mm}^2$$

$$\text{Permissible axial comp stress} = \frac{3900}{28.4 \times 10^2} = 1.37 \text{ N/mm}^2$$

Calculation for permissible compressive Building stress As per clause 6.3 of IS 801 – 1975

$$F_b = 0.6 f_y$$

$$= 0.6 \times 3450$$

$$= 2070 \text{ kg/cm}^2$$

$$= 207 \text{ N/mm}^2$$

Under wind load combination $F_b = 207 \times 1.33$

$$= 275.31 \text{ N/mm}^2$$

$$(w/t)_{Lim} = \frac{1435/\sqrt{f} \{ \bar{f} = 0.75 \times 2000, = 1500 \text{ kg/cm}^2 \}}{= 1435/\sqrt{1500}}$$

$$= 37$$

Calculation for permissible compressive stress As per clause 6.3 of IS 801 – 1975

Referring to Clause no.6.3 (a) of IS: 801-1975. L = 1.5m is Unbraced Length

$$S_{xc} = Z_{xx} 156.4 \text{ cm}^3$$

$$I_{yc} = I_{yy}/2 = 432/2$$

$$= 216 \text{ cm}^4$$

$$\frac{l^2 s_{xc}}{d I_{yc}} = \frac{150^2 \times 156.4}{18 \times 216}$$

$$= 905 \longrightarrow (1)$$

$$\frac{0.36 \pi^2 \times E \times C B}{f_y}$$

$$\frac{0.36 \pi^2 \times 2 \times 10^6 \times 1}{3450}$$

$$= 2060 \longrightarrow (2)$$

$$\frac{1.8 \pi^2 \times E \times C B}{f_y}$$

$$\frac{1.8 \pi^2 \times 2 \times 10^6 \times 1}{3450}$$

$$= 10299 \longrightarrow (3)$$

$$(1) < (2)$$

$$(1) < (3)$$

Hence $F_b = 275.31 \text{ N/mm}^2$

$$F_b = 275.31 \text{ N/mm}^2$$

$$F_{b_{act}} = \frac{22.28 \times 10^6}{156.4 \times 10^3}$$

$$= 142.46 < 275.3 \text{ Mpa}$$

Unity Check

Referring to Clause number 6.7.2 of IS: 801-1975

$$\frac{f_a}{F_{a1}} = \frac{1.37}{169.76} = 0.0080 < 0.15$$

$$\frac{f_a}{F_{a1}} = \frac{142.46}{275.76} = 0.52$$

$$= \frac{f_a}{F_{a1}} + \frac{F_b}{F_{b1}} < 1$$

$$= \frac{f_a}{F_{a1}} + \frac{F_b}{F_{b1}} < 0.52 < 1$$

Hence safe

Check for Deflection

$$\delta_{allow} = \frac{span}{120} = \frac{5840}{120} = 48.67 \text{ mm}$$

Calculated Deflection due to Wind load on Column

$$\begin{aligned} \delta_{Cal} &= \frac{5wl^3}{384 EI} \\ &= \frac{5 \times 23.65 \times 10^3 \times 5840^3}{384 \times 2 \times 10^5 \times 1408 \times 10^4} \\ &= 21.78 \text{ mm} \end{aligned}$$

$$= 21.78 < \delta_{allow} = 48.67 \text{ mm}$$

Hence the column is found safe when checked for deflection

3.1.7 MAIN FRAME DESIGN LOAD CALCULATION : –

Dead Load

Dead weight (Roof Sheeting & Purlins) on frame is considered as 0.172 kN/m² Hence, Loads on rafter as U.D.L = 0.17 x 6.25 = 1.0625 KN/m Loads on Column = 0.17 x 1.5 x 6.25 = 1.59 KN
Total Load transferred by Girt & Sheeting on Column = 1.59 x 3 = 4.78 KN

Service Load

Service Load on the Rafter is considered as 0.1 kn/m²
Hence, Loads on rafter as U.D.L = 0.1 x 6.25 = 0.625 KN/m

Imposed Load

As $\phi < 10^0$ Live Load = 0.752
Hence, Loads on rafter as U.D.L = 0.75 x 6.25 = 4.6875 KN/m

Wind Load:

Wind load on the frame due to wind
= 9 x 6.25 x 0.9 x (1.2 + 0.2)
= 70.875 KN

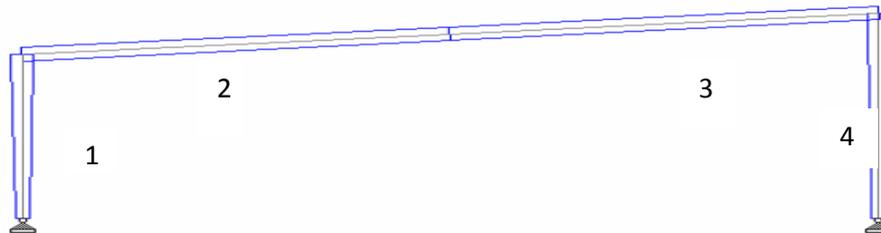

Figure 3.1.11 The Frame With Configuration Of All Four Members

Table 3.1.3: properties of member of the frame

Member No	Depth at start node	Depth at end Node	Width of flange	Thickness of Flange	Thick ness of web
1	250mm	400mm	200mm	10mm	6mm
2	400mm	400mm	200mm	10mm	6mm
3	400mm	400mm	200mm	10mm	6mm
4	400mm	250mm	200mm	10mm	6mm

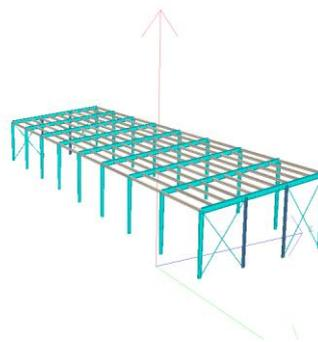

Figure 3.1.12: 3D view of CFS

Check for Deflection

Max^m permissible Defⁿ due to wind load only for frame = $h/60$ to $h/100$ (horizontal)
 $= \frac{5000}{60}$ to $\frac{5000}{100}$
 $= 83.33\text{mm}$ to 50 mm

Maximum permissible Vertical Deflection due to live load on frame

$= \frac{\text{span}}{240} = \frac{15000}{240} = 62.5\text{mm}$

The frame was checked for horizontal at node 2 & 4 for wind load & was found to be safe. The frame was checked for vertical deflection at node for 3 & was found safe.

The Weight of Cold Formed Industrial Building

The total weight of Cold Formed Steel Industrial Building having area 15x50 m. & eave height 5 m. was found to be 15.92 Ton & cost of building is estimated 11.14 Lakh. The cost of cold formed steel is 70Rs/Kg

3.2 ANALYSIS & DESIGNS OF HOT ROLL STEEL INDUSTRIAL BUILDING USING SOFTWARE

3.2.1 PARAMETERS OF HOT ROLLED INDUSTRIAL BUILDING

- Location : Nagpur
- Utility : Cement Godown
- Building Width : 15m
- Building Length : 50 m
- Eave Height : 5m
- C/C of Main frames : 6.25 m
- Maximum spacing of purlin : 1.5 m
- Slope of Roof : 1:12
- Structural material yield stress : 250Mpa

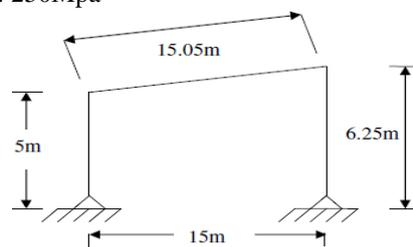

Figure 3.2.1: Elevation of HRS

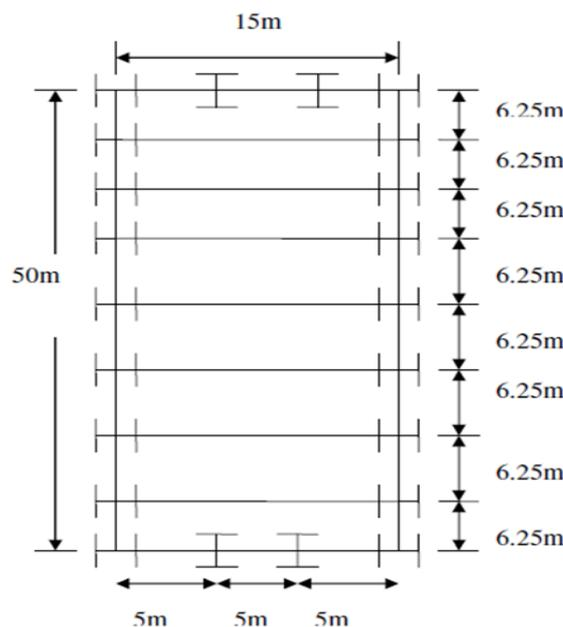

Figure 3.2.2: Plan of HRS

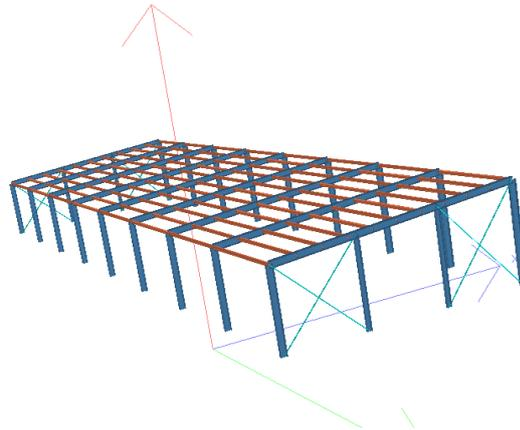

Figure 3.2.3: 3D View of HRS

Table 3.2.1 Result of Conventional Industrial Building

Sr. No.	Member description	Section	Total wt (TN)
1	Rafter	ISMB-400	7.7
2	Purlins	ISJC-175	10.30
3	Main columns	ISMB-400	3.8
	Main columns	ISMB-350	1.59
4	Gable end wind column	ISMB-350	0.71
5	Tie runners	ISMB-250	0.821
	Total weight		25.159

The total weight of Conventional Industrial Building having area of 15×50 m & eave height 5m was found to be 25.159 Ton & cost of building is estimated 15.09 Lakh. Cost of Hot Rolled steel is 60 Rs/Kg.

Chart plotted for the weight of Cold Formed Steel Industrial Building & Conventional Building by the cost

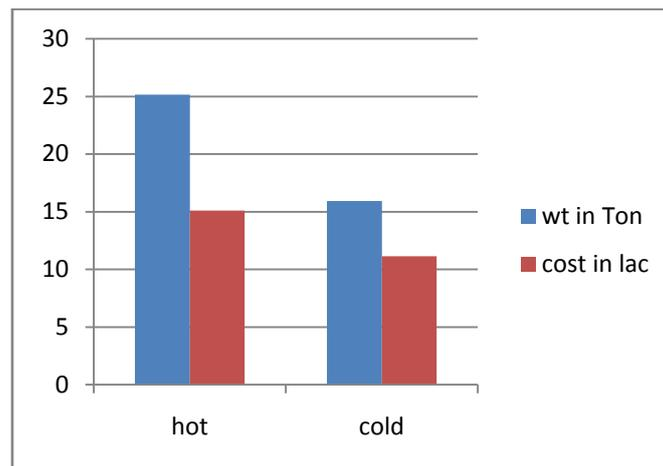

Figure3.2.4: chart plotted between cost and weight of CFS and HRS

IV. RESULT AND CONCLUSION

4.1 RESULT Case1:

With the analysis and design of section, it has been observed that by using cold formed steel building instead of hot rolled steel building the material is saved by using cold formed steel was 9.239 T & cost is saved to 5.54 lakh. The spacing of c/c main frame is 7.14m.

Case2:

With the analysis and design of section, it has been observed that by using cold formed steel building instead of hot rolled steel building the material is saved by using cold formed steel was 13.92 T & cost is saved to 8.35 lakh. The spacing of c/c main frame is 6.67m.

4.2 CONCLUSION

In Industrial building the material & cost of the building is minimized in case of cold formed steel while in case of conventional building it was be higher both in two cases. The saving in material and cost is about 25 %.

4.3 FUTURE SCOPE

Analysis and Design of Cold Formed Steel done for multi-storey building by considering various sectional properties of cold formed steel. Also design different parts such as eave strut, bracing system, sag rod and foundation can be done for different consideration of section.

REFERENCES

Books:

- [1.] S. K Duggal "Design of steel structure".
- [2.] N.S Negi "Design of steel structure".
- [3.] Dr. B C Punmia Ashok Jain ,Arun Kumar Jain "Design of steel structure "By laxmi publication.
- [4.] Insdag publication "Design handbook for cold formed steel section part-1"section Properties.

IS Code:

- [5.] IS 800-1984 Indian standard code of practice for general construction in steel.
- [6.] IS : 800-1984 : Code of practice for general construction in steel.
- [7.] IS : 801-1975 : Code of practice for use of Cold-formed light gauge steel structure member's is general building construction.
- [8.] IS : 875 (Part 2) – 1987 : Imposed loads.
- [9.] IS : 875 (Part 3) – 1987 : Wind loads.
- [10.] BS : 5950 (Part 5) – 1998 : Code of practice for design of Cold – formed thin gauge section.

Journal Papers:

- [11.] Stability and ductility of steel structures Lisbon, Portugal, September 2006 review: the direct strength method of cold-formed steel member design.
- [12.] Proceedings of the 6th Asia-Pacific Structural Engineering and Construction Conference (APSEC 2006), 6 September 2006, Kuala Lumpur, Malaysia typical tests on cold-formed steel structures.
- [13.] Scientific Research and Essays 18 July, 2010 Academic Journals Linear buckling optimization and post-buckling behaviour of optimized cold formed steel members.
- [14.] Department of Civil Engineering, Hong Kong University of Science and Technology, 2003 The Steel Construction Institute tests of cold-formed stainless steel tubular columns.
- [15.] Finnish Constructional Steelwork Association, Finland, Tornio Research Centre, Outokumpu Tornio Works, Finland new design tools for structural hollow sections of stainless steel (2008).
- [16.] Department of Civil Engineering, Faculty of Sciences and Technology, University of Coimbra, Coimbra, Portugal Fire resistance of a cold formed steel roof beam (2009)
- [17.] Journal Technology, Jun. 2005 University Technology Malaysia. Performance of locally produced cold-formed steel sections for roof.